



PRO ARMOR

POLARIS RAZR (P081208) DOOR SHEETS INSTALLATION INSTRUCTIONS

Please read these instructions carefully before installation to prevent injury to yourself or damage to your vehicle.

PARTS LIST:

PART	DESCRIPTION	QTY
1	DOOR SHEET (LEFT)	1
2	DOOR SHEET (RIGHT)	1

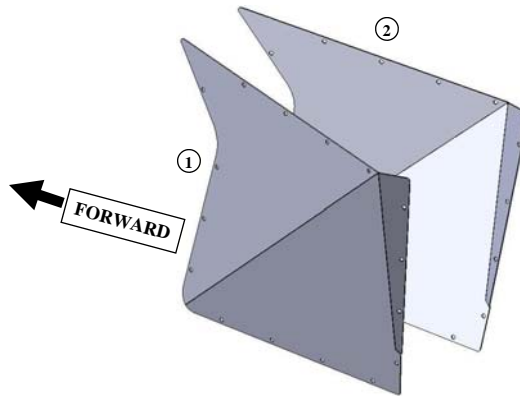

PREPARATION:

1. P081207 Door Sheets are to be installed with the P081202 Side door application. Please make sure that the side doors are properly installed on the vehicle. Locate the mounting hardware for the door sheets from the P081202 hardware kit. The hardware should consist of (32) M6 x 16mm button head bolts, (32) 6mm washers and (32) M6 nyloc nuts.

INSTALLATION:

1. Position the left door sheet over the main swinging section of the left side door. Align the mounting holes of the door sheet to the mounting tabs located on the door. Loosely install (1) M6 x 16mm button head bolt, (1) 6mm washer and (1) M6 nyloc nut at each of the mounting points. With all mounting points located and mounting hardware (16 each) loosely installed, tighten down the mounting bolts securing the left door sheet to the left door. See Fig. 1 and 2 below.
2. Repeat the procedure for the right door sheet on the right side door.

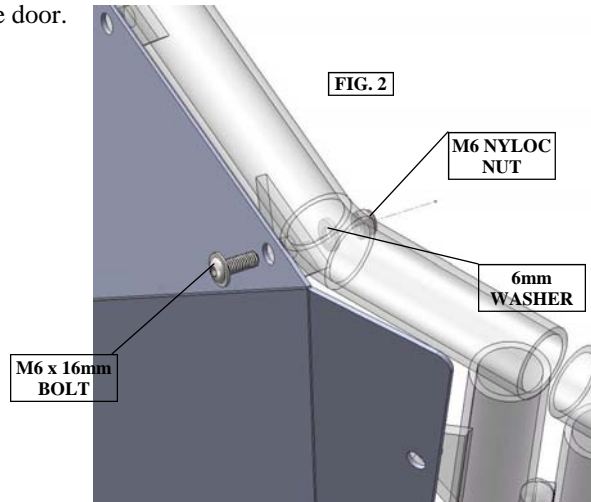
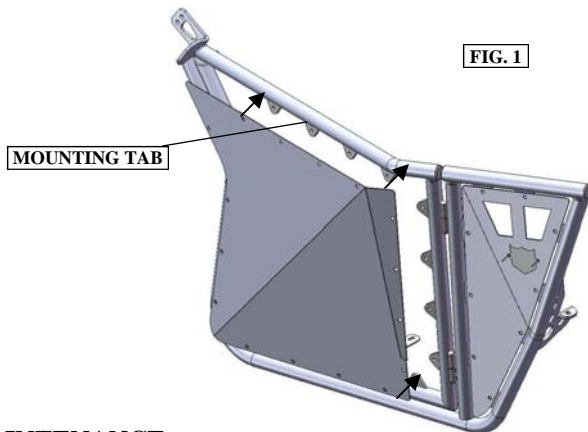

MAINTENANCE:

Periodically check to see that the doors sheets are properly installed. Re-torque mounting bolts when necessary. **Do not operate the vehicle if any bolts or fasteners are loose or missing from the doors. Do not operate the vehicle with door(s) open!**

CUSTOMER SERVICE:

For further information, please contact Pro Armor at 1-951-343-9270.